

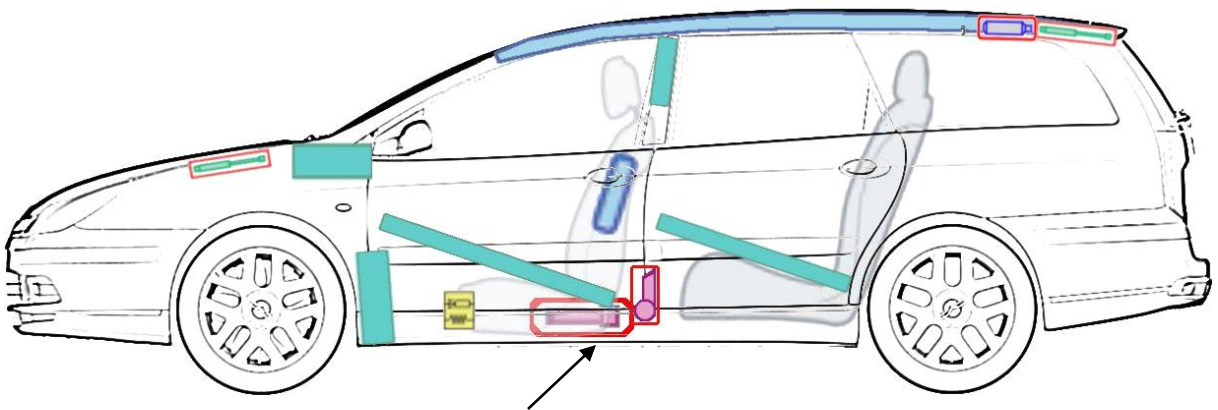

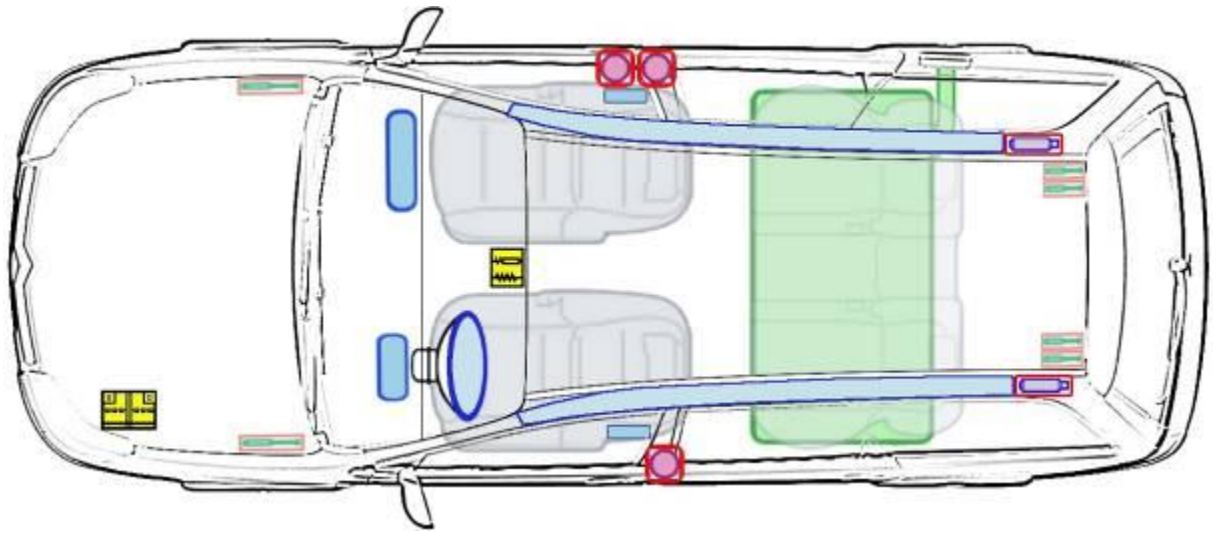















Citroën C5 Tourer (2001 to 2008)



Pyrotechnic lap belt return for the front passenger only

Legende

	Airbag		Structural reinforcements		Battery		Control Unit
	Pyrotechnical generator		Seat belt tensioner		Pyrotechnical Rollover protection		Stfromilizer
	Gas tank		Safety valve		Fuel tank		e-Booster
	Fuse box		High Voltage Circuit		High Voltage Battery		High Voltage disconnection